



PRE KINDY PARENT SUPPORT PACK 1



Baa, Baa, Black Sheep

Baa, baa, black sheep,

Have you any wool?

“Yes sir, yes sir, three bags full!”

One for the master...

One for the dame...

And one for the little boy,

Who lives down the lane.



The Farmer's In His Den

The farmer's in his den,
The farmer's in his den,
EE, I, addy-O,
The farmer's in his den.

The farmer wants a wife...

The wife wants a child...

The child wants a nurse...

The nurse wants a dog...

The dog wants a bone...

We all pat the bone...

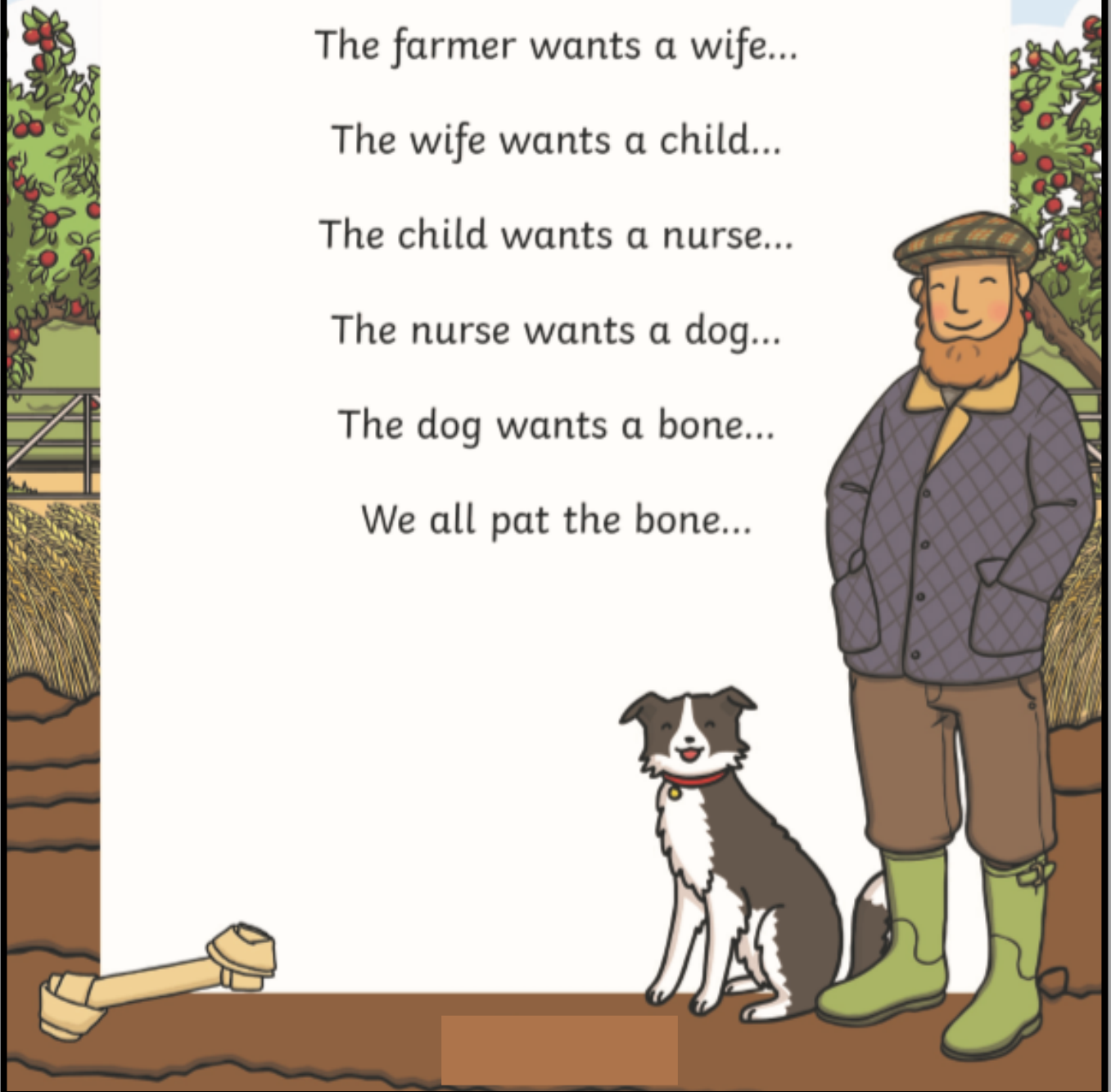

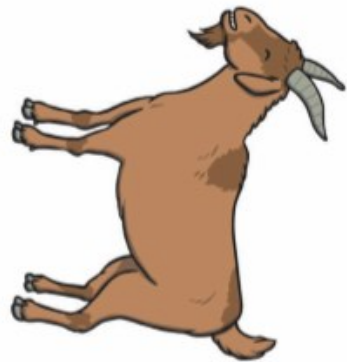
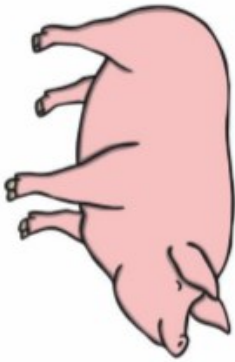
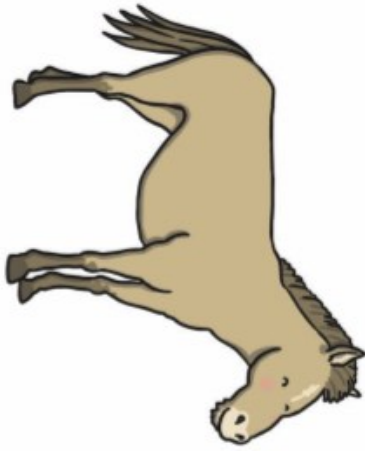
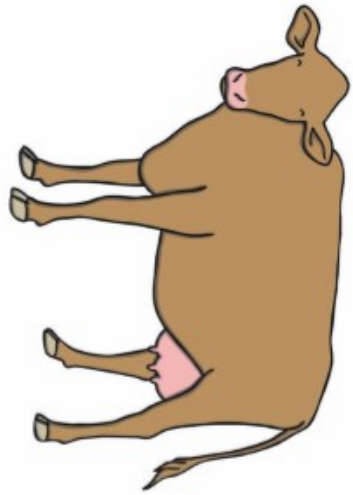
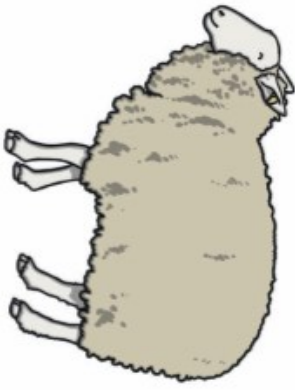

I Can See the Farm Activity

You will need to:

- Lay the mat in a tray.
- Cover the mat in a thin layer of rice to make a farmyard.
- Gather a selection of farm yard animal toys to match the pictures.

Busy Bag

I Can See the Farm Activity

What animals can you see?

Where is the horse/ pig/ sheep/ goat etc.?

What sound does that animal make?

What can you find hidden in the grain?

Can you slowly make a path through the farm?

Can you match the animals to their pictures?



cat



dog



kitten



puppy



cow

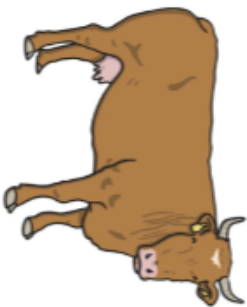

horse



calf



foal



pig

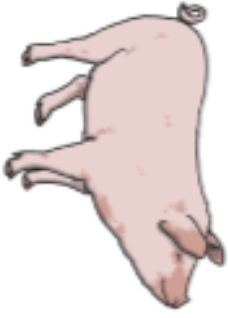

elephant



piglet



elephant calf



frog



owl

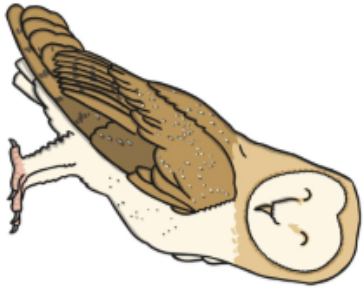

tadpole



owlet



duck



bear



ducklings



bear cub



chicken



sheep



chick



lamb



butterfly



deer

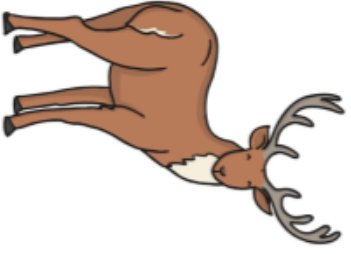

caterpillar



fawn



rabbit



goat



kitten (kit)



kid



Regrowing Vegetables

Science Experiment



Method

1. Carrot - Place the top cut-off end of a carrot in a shallow bowl of water. The green leaves will shoot from the top. Keep inside and place in a sunny spot.
2. Celery - Cut off the bottom 8cm of the stalk and place in a small bowl of water. After 3 or 4 days it will start to grow from the centre of the celery. Keep inside and place in a sunny spot.
3. Lettuce - Cut off the bottom of the head of lettuce and place it in a small bowl of water. It will start to regrow in around 3 days. Keep inside and place in a sunny spot.
4. Spring Onion - Use the white part of the onion, with any roots still intact. Place in a glass with water and it will start to grow. Keep inside and place in a sunny spot.

You will need:

Water
Bowls
Carrot
Celery
Romaine lettuce
Spring onion
Knife



Science Experiment

Regrowing Vegetables

With the help of your grown-up, cut the vegetables and place them in a sunny spot to grow.

Check your vegetables every day.

Can you see any new growth?

What is growing - the shoots, leaves or roots?



Finger Gym

Tractors in a Tangle

The tractors have got in a bit of a tangle.

How do you think they got in such a mess?

Can you help them?

Can you untangle the string to free the tractors?

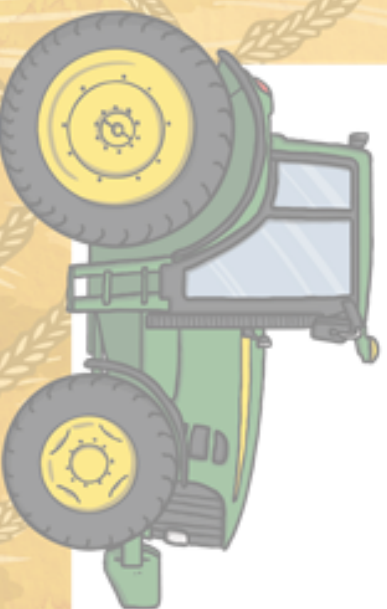

twinkl

Tractor Threading Pictures

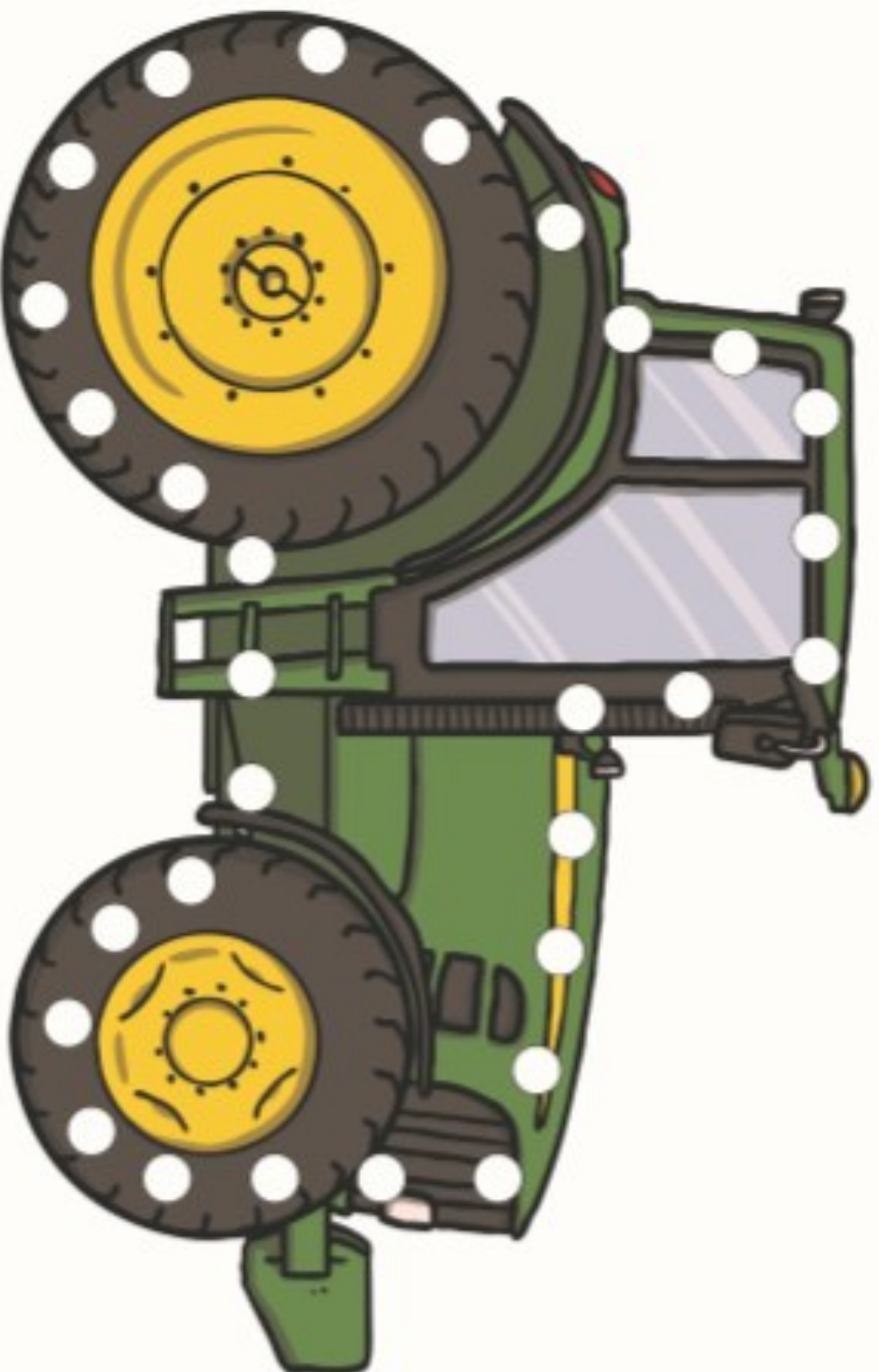

Tractor Threading Pictures

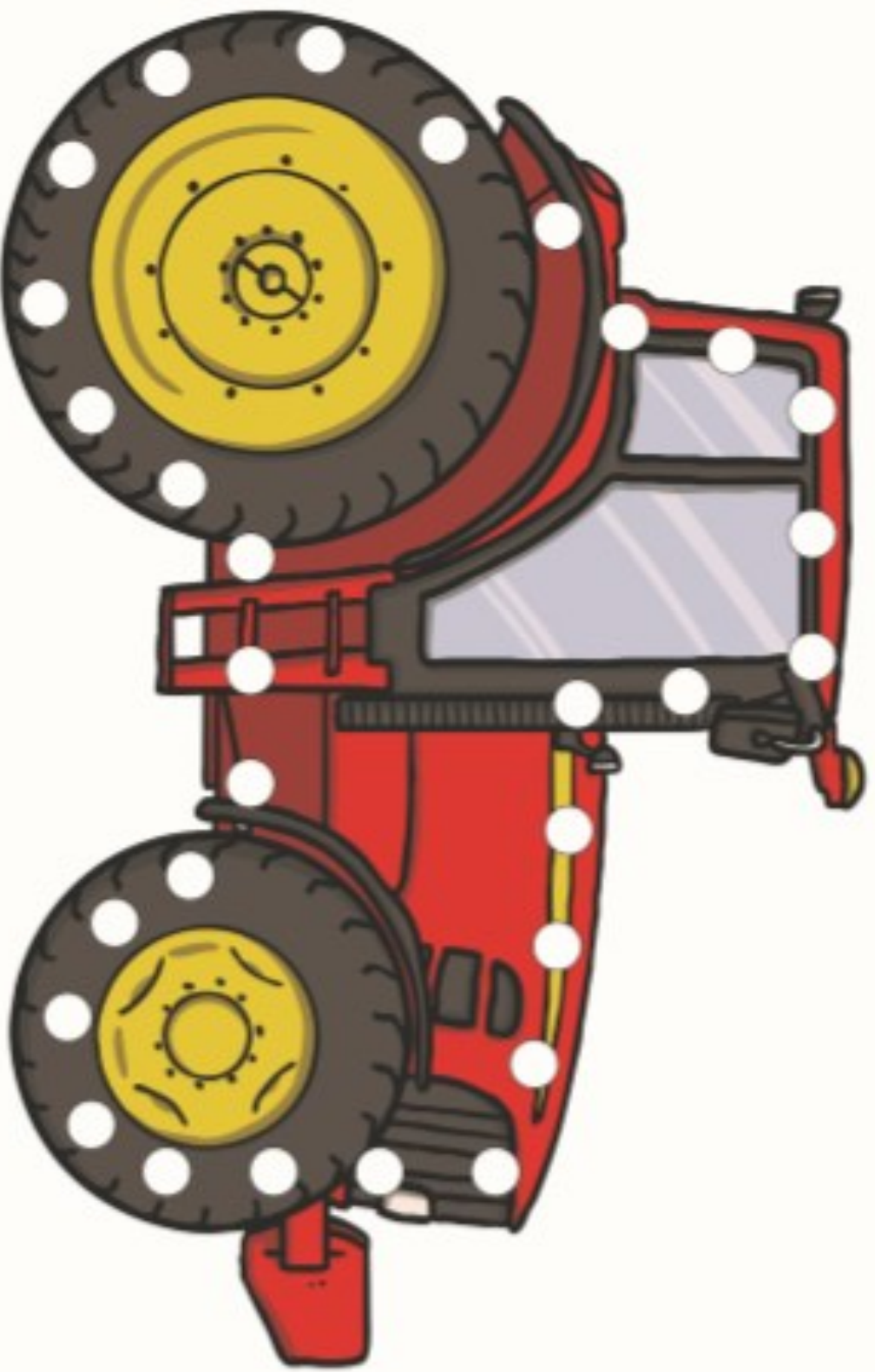

Tractor Threading Pictures

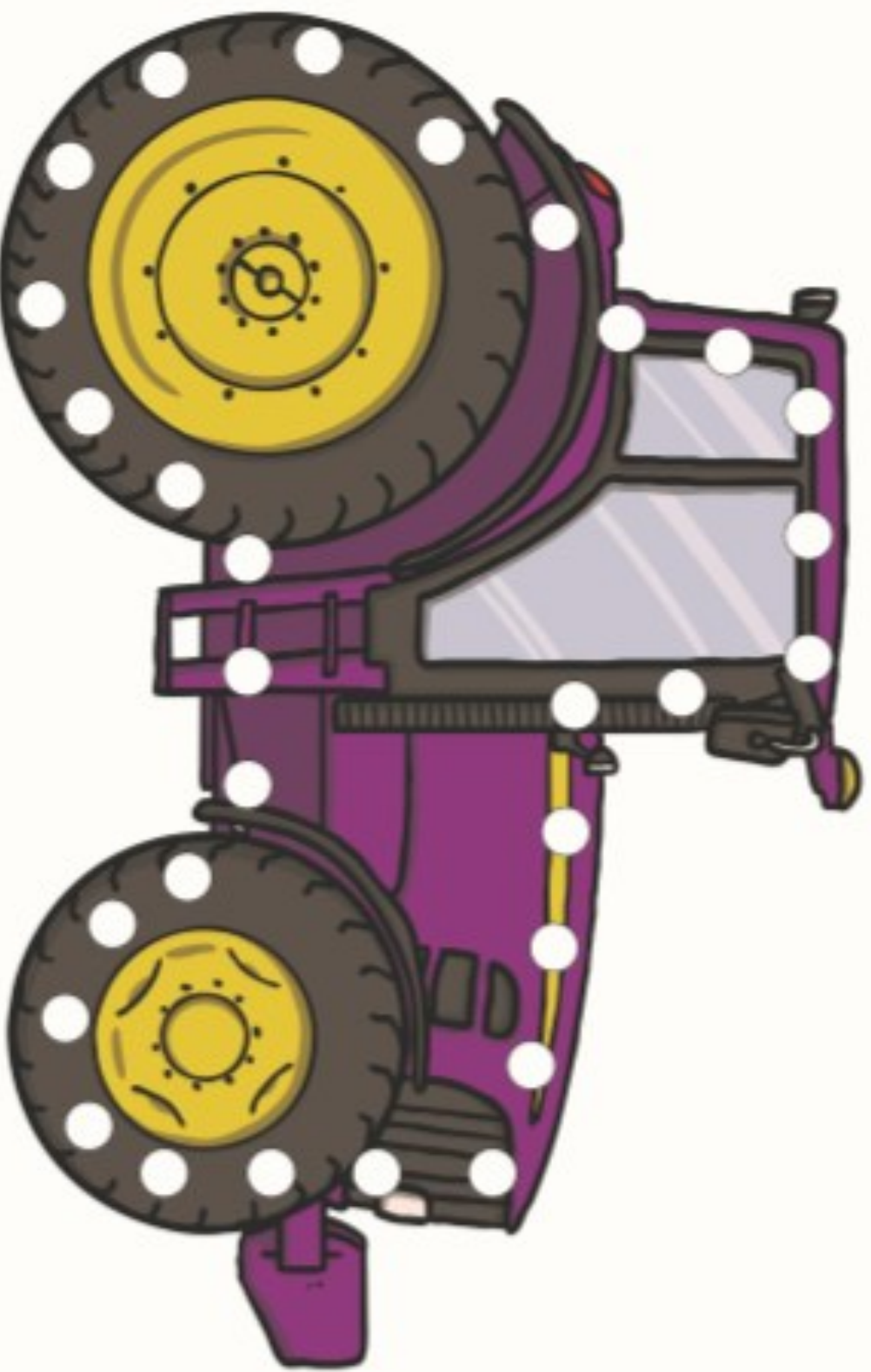

cattle grid



chicken

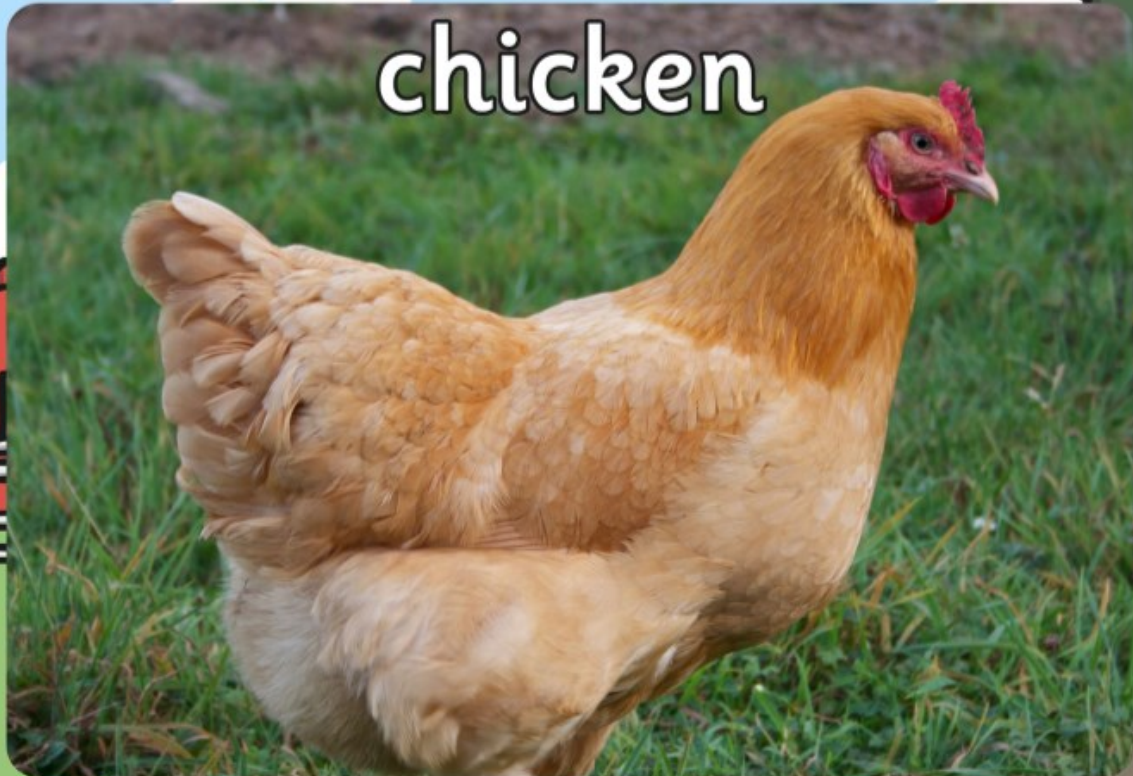

combine harvester



COW



duck



donkey



farmhouse



goat





sheep



goose

straw bale



horse



tractor



pig





farmhouse



barn



farmer



field

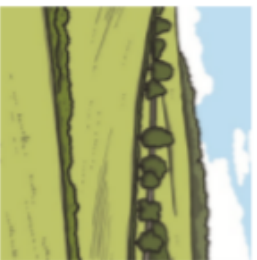

tractor



haystack



straw bale



combine



harvester

duck



goose



horse



udder



goat



sheep



hen



cockereel



donkey



pig

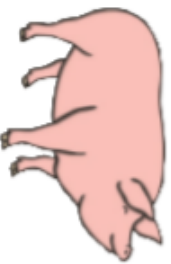

dog



cat



wool



butter



cheese



eggs



milk



pond



gate



trailer



cattle grid



milk churn

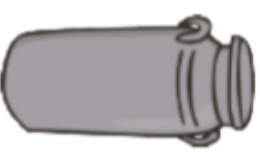

COW



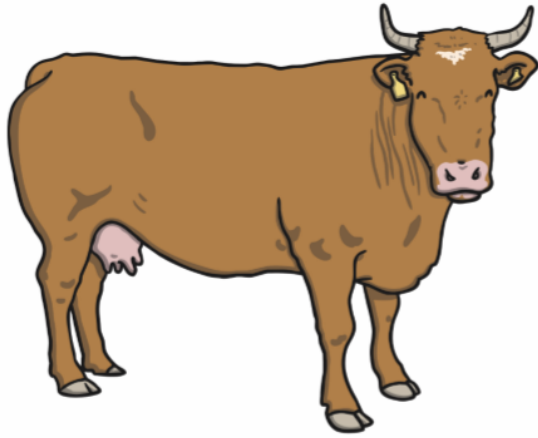
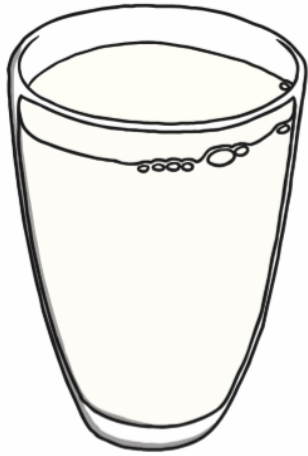

Milk comes from a **cow**.

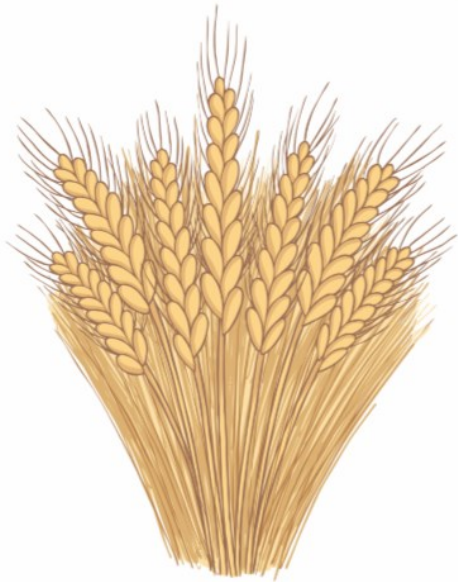
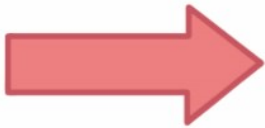
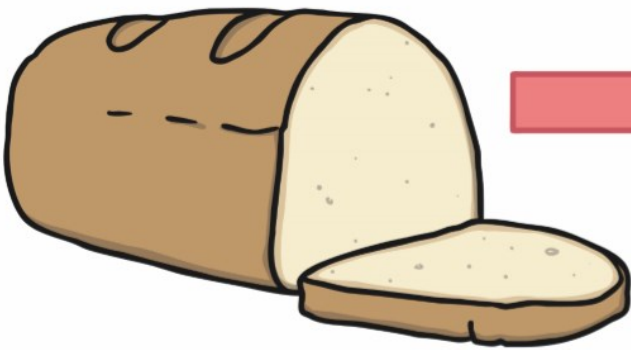

Bread comes from **wheat**.

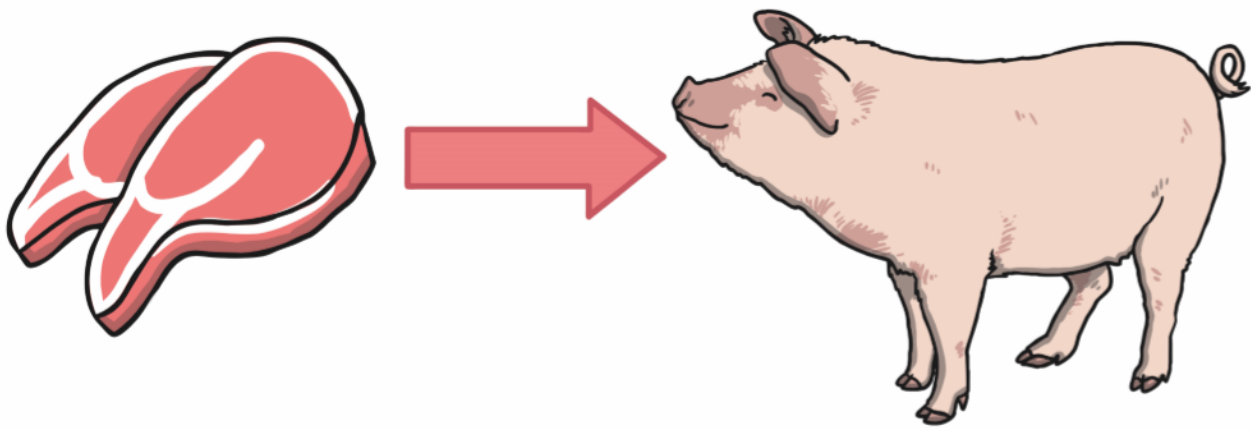

Pork comes from **pigs**.

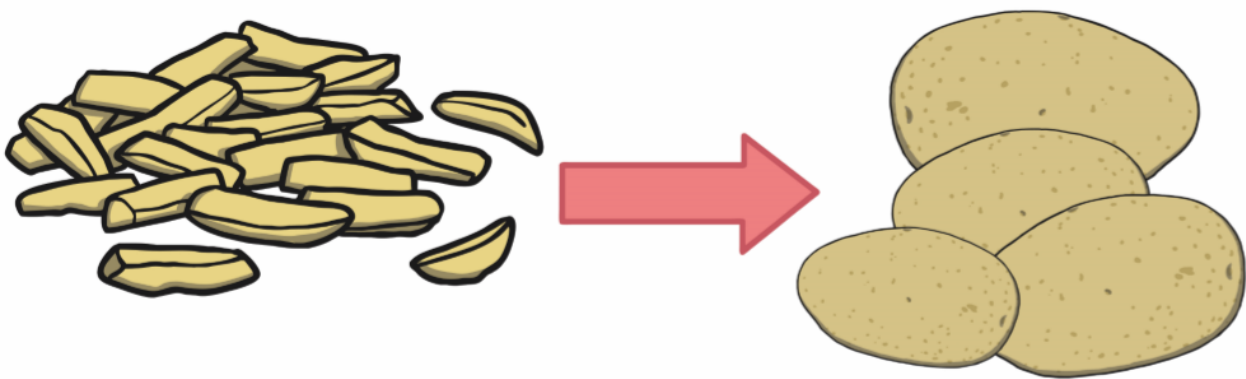

Chips come from **potatoes**.

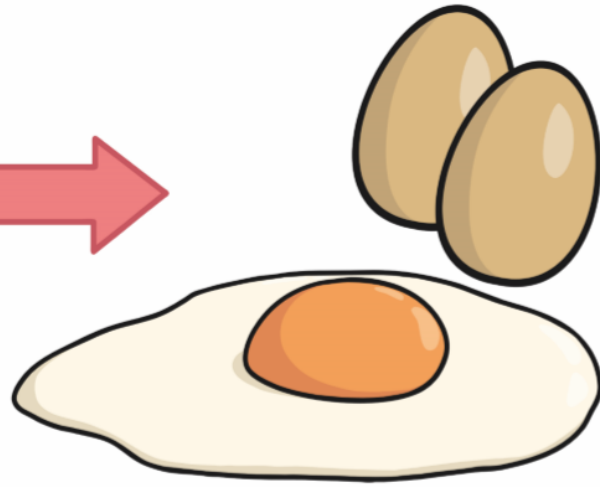

Chickens lay eggs.

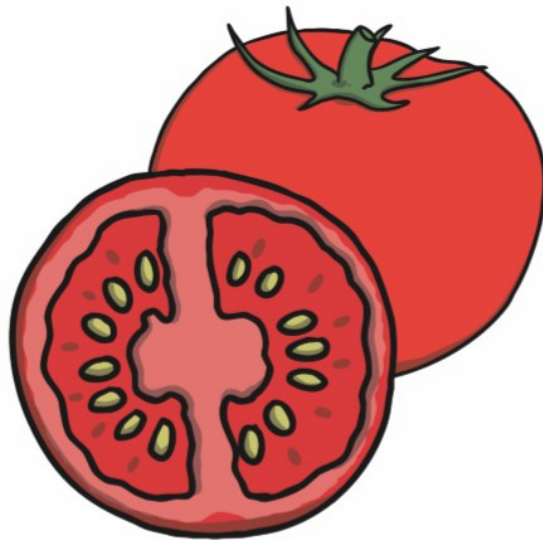
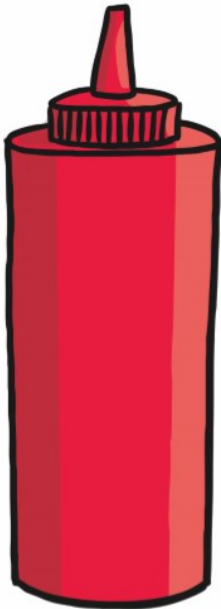

Tomato sauce is made from tomatoes.

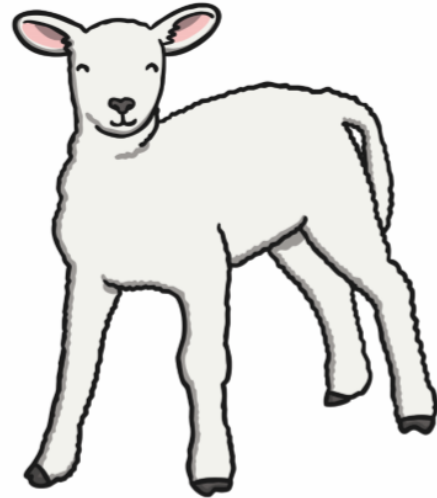

Lamb comes from **baby sheep**.

Farm

Discovery Sack Fact Cards



Farm

Farms are places where farmers grow crops for food. Sometimes animals live on the farms too. Farmers are people who work on the farm. They look after the animals, as well as planting and harvesting the crops. Farmers and their families often live on the farm too.



Farm

There are lots of different types of farm animals. They often give us food and other things, such as the wool we get from sheep. Some farm animals are; cows, sheep, chickens, pigs, goats and ducks. Cats and dogs are often kept on farms too.



twinkl.com

Farm

Cows are large animals that usually have black and white patches on their skin. Male cows are called 'bulls' and the females are called 'cows' or 'heifers'. Baby cows are called 'calves'. Cows give us milk and beef. A group of cows is called a 'herd'.



twinkl.com

Farm

Sheep are woolly animals that have thick, creamy-white coloured wool covering most of their bodies. Female sheep are called 'ewes' and males are called 'rams'. Baby sheep are called 'lambs'. Sheep give us wool and lamb meat. A group of sheep is called a 'flock'. In the summer, sheep are sheared to remove their thick wool. The wool is used to make many things, such as clothes and carpets.



twinkl.co.uk

Farm

Chickens are small, feathery birds. Female chickens are called 'hens' and males are called 'roosters' or 'cockerels'. Babies are called 'chicks' and hatch from eggs. Chickens give us eggs and chicken meat. Some people keep chickens in gardens at their homes too.



twinkl.co.uk

Farm

Pigs are pink farm animals. They have snouts and curly tails and like to roll in mud to keep cool. Male pigs are called 'boars' and females are called 'sows'. Baby pigs are called 'piglets'. Pigs give us meats such as pork, ham and bacon.



twinkl.co.uk

Farm

Goats often have white or brown hair, short tails and small horns. They are very good at climbing. They have small hooves. Male goats are called 'bucks' or 'billy goats' and females are called 'does' or 'nanny goats'. Baby goats are called 'kids'. Goats give us meat and milk. Some types of goat hair are used to make clothes.



twinkl.co.uk

Farm

Ducks are small birds that are sometimes found on farms or by ponds and rivers. They are good at swimming and have webbed feet. They have beaks called 'bills'. They make a 'quack' sound. Male ducks are called 'drakes' and females are called 'ducks' or 'hens'. Baby ducks are called 'ducklings'.



twinkl.com

<https://www.twinkl.com/primary-resources/worksheets/primary-farm-animals-worksheets>

Farm

Cats are often found on farms. They are often kept as pets too. On farms, they have a special job - to chase and hunt mice, to stop them eating all of the crops. They are good at hunting and like to chase and pounce on things. Baby cats are called 'kittens'. They come in lots of different colours such as black, white, ginger and brown, and have soft fur.



twinkl.com

Farm

Dogs are often found on farms. They are often kept as pets too. On farms, they have lots of special jobs - such as to protect the other farm animals from foxes. Some dogs have also been trained to round up and herd sheep. Baby dogs are called 'puppies'. They have very good senses, especially smelling and hearing.



twinkl.com

Farm

Lots of different foods are often grown on farms. These are called 'crops'. Crops that you might find growing on a farm include wheat, fruit and vegetables.



twinkl.com

Farm

Wheat is a type of grain. Wheat grains are ground into flour. Flour is used to make lots of different foods including bread, pastry, cakes and biscuits.



twinkl.co.uk

Farm

Lots of fruit and vegetables are grown on farms, such as potatoes, carrots, lettuces, tomatoes, broccoli, cauliflowers and peas. Many of these crops grow on small plants or under the ground. Some fruit, such as apples and pears, grow on tall trees.



twinkl.co.uk

Farm

Farmers use lots of machines to help plant and harvest the different foods. They use machines like tractors, ploughs and combine harvesters.



twinkl.co.uk

Farm

Scarecrows are sometimes seen in fields where crops are growing. Scarecrows often look a bit like a person, standing up tall and straight with their arms stretched out. They are used to scare birds away from the seeds and plants, which they would like to eat. They are often dressed in old clothes and stuffed with straw.



twinkl.co.uk